

User Manual

ANNKE

Thank you very much for choosing ANNKE.

Our products are supported by the world's first video monitoring manufacturers,
and they have adopted military level of protection.

It is our top priority to ensure your data safety and offer you a satisfactory service.

We strongly recommend that you set up an appropriate password for your device and save it,
also set up security questions and reserved email to ensure you can reset password by yourself.

If you have any questions, please feel free to email us at **support@annke.com**.

Or visit our help center: **help.annke.com**.

Please download ANNKE App, Client software and user manuals from our download center:

<https://www.annke.com/pages/download-center>

Free call for US and CA, +1 833 717 0187

About this Manual

The Manual includes instructions for using and managing the product. Pictures, charts, images and all other information hereinafter are for description and explanation only. The information contained in the Manual is subject to change, without notice, due to firmware updates or other reasons. Please find the latest version in the company website . Please use this user manual under the guidance of professionals.

Legal Disclaimer

REGARDING TO THE PRODUCT WITH INTERNET ACCESS, THE USE OF PRODUCT SHALL BE WHOLLY AT YOUR OWN RISKS. OUR COMPANY SHALL NOT TAKE ANY RESPONSIBILITES FOR ABNORMAL OPERATION, PRIVACY LEAKAGE OR OTHER DAMAGES RESULTING FROM CYBER ATTACK, HACKER ATTACK, VIRUS INSPECTION, OR OTHER INTERNET SECURITY RISKS; HOWEVER, OUR COMPANY WILL PROVIDE TIMELY TECHNICAL SUPPORT IF REQUIRED. SURVEILLANCE LAWS VARY BY JURISDICTION. PLEASE CHECK ALL RELEVANT LAWS IN YOUR JURISDICTION BEFORE USING THIS PRODUCT IN ORDER TO ENSURE THAT YOUR USE CONFORMS THE APPLICABLE LAW. OUR COMPANY SHALL NOT BE LIABLE IN THE EVENT THAT THIS PRODUCT IS USED WITH ILLEGITIMATE PURPOSES. IN THE EVENT OF ANY CONFLICTS BETWEEN THIS MANUAL AND THE APPLICABLE LAW, THE LATER PREVAILS.

Regulatory Information

FCC Information

Please take attention that changes or modification not expressly approved by the party responsible for compliance could void the user's authority to operate the equipment.

FCC compliance: This equipment has been tested and found to comply with the limits for a Class B digital device, pursuant to part 15 of the FCC Rules. These limits are designed to provide reasonable protection against harmful interference in a residential installation. This equipment generates uses and can radiate radio frequency energy and, if not installed and used in accordance with the instructions, may cause harmful interference to radio communications. However, there is no guarantee that interference will not occur in a particular installation. If this equipment does cause harmful interference to radio or television reception, which can be determined by turning the equipment off and on, the user is encouraged to try to correct the interference by one or more of the following measures:

- Reorient or relocate the receiving antenna.
- Increase the separation between the equipment and receiver.
- Connect the equipment into an outlet on a circuit different from that to which the receiver is connected.
- Consult the dealer or an experienced radio/TV technician for help.

Changes or modifications not expressly approved by the party responsible for compliance could void the user's authority to operate the equipment.

This device complies with Part 15 of the FCC Rules.

Operation is subject to the following two conditions:

(1) this device may not cause harmful interference, and (2) this device must accept any interference received, including interference that may cause undesired operation.

RF Exposure Warning Statements:

This equipment complies with FCC radiation exposure limits set forth for an uncontrolled environment. This equipment shall be installed and operated with minimum distance 20cm between the radiator & body.

EU Conformity Statement



This product and - if applicable - the supplied accessories too are marked with "CE" and comply therefore with the applicable harmonized European standards listed under the Low Voltage Directive 2015/35/EU, the EMC Directive 2014/30/EU, the RoHS Directive 2011/65/EU.



2012/19/EU (WEEE directive): Products marked with this symbol cannot be disposed of as unsorted municipal waste in the European Union. For proper recycling, return this product to your local supplier upon the purchase of equivalent new equipment, or dispose of it at designated collection points. For more information, please see: www.recyclethis.info.





2006/66/EC (battery directive): This product contains a battery that cannot be disposed of as unsorted municipal waste in the European Union. See the product documentation for specific battery information. The battery is marked with this symbol, which may include lettering to indicate cadmium (Cd), lead (Pb), or mercury (Hg). For proper recycling, return the battery to your supplier or to a designated collection point. For more information, please see: www.recyclethis.info.

Safety Instruction

These instructions are intended to ensure that user can use the product correctly to avoid danger or property loss. The precaution measure is divided into “Warnings” and “Cautions”.

Warnings: Serious injury or death may occur if any of the warnings are neglected.

Cautions: Injury or equipment damage may occur if any of the cautions are neglected.

	Warnings: Follow these safeguards to prevent serious injury or death.
	Cautions: Follow these precautions to prevent potential injury or material damage.



Warnings

- Proper configuration of all passwords and other security settings is the responsibility of the installer and/or end-user.
- In the use of the product, you must be in strict compliance with the electrical safety regulations of the nation and region. Please refer to technical specifications for detailed information.
- Input voltage should meet both the SELV (Safety Extra Low Voltage) and the Limited Power Source with 100~240 VAC or 12 VDC according to the IEC60950-1 standard. Please refer to technical specifications for detailed information.
- Do not connect several devices to one power adapter as adapter overload may cause over-heating or a fire hazard.
- Please make sure that the plug is firmly connected to the power socket.
- If smoke, odor or noise rise from the device, turn off the power at once and unplug the power cable, and then please contact the service center.



Cautions

- Make sure the power supply voltage is correct before using the camera.
- Do not drop the camera or subject it to physical shock.
- Do not touch sensor modules with fingers. If cleaning is necessary, use clean cloth with a bit of ethanol and wipe it gently. If the camera will not be used for an extended period, replace the lens cap to protect the sensor from dirt.
- Do not aim the camera at the sun or extra bright places. Blooming or smearing may occur otherwise (which is not a malfunction), and affect the endurance of sensor at the same time.
- The sensor may be burned out by a laser beam, so when any laser equipment is in using, make sure that the surface of sensor will not be exposed to the laser beam.
- Do not place the camera in extremely hot, cold (the operating temperature shall be -30°C to +60°C, or -40°C to +60°C if the camera model has an "H" in its suffix) , dusty or damp locations, and do not expose it to high electromagnetic radiation.
- To avoid heat accumulation, good ventilation is required for operating environment.
- Keep the camera away from liquid while in use.
- While in delivery, the camera shall be packed in its original packing, or packing of the same texture.

TABLE OF CONTENTS

EN

1. Interface Introduction.....	07
2.Connection method.....	08
3. Activating your device.....	09
4. Operate IP camera via browser.....	11
5. Remote control via APP ANNKE Vision.....	14
6. Operate IP camera via PC client Guarding Vision.....	16
7. View live stream via RTSP protocol.....	18
8. Work with ANNKE NVR.....	19
9. Install the Camera.....	20
10. Waterproof the camera.....	20

DE

1. Schnittstelleneinführung.....	22
2. Verbindungsmethode.....	23

1. Interface Introduction

The pictures and descriptions in this manual are for reference only, please refer to the actual product.

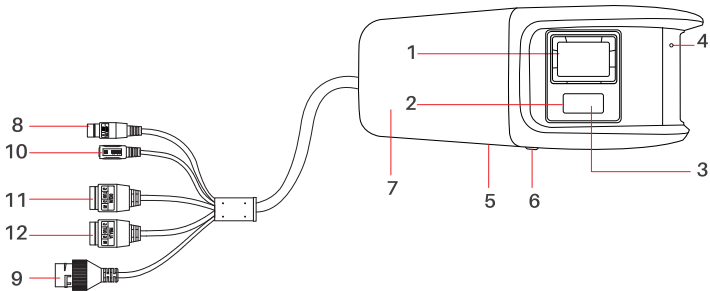

No.	Description	No.	Description
1	Lens	2	Supplement Light
3	White Light	4	Microphone
5	Reset Button	6	Memory Card Slot
7	Speaker	8	DC 12V output
9	PoE&Network Interface	10	DC 12V Power Interface
11	Audio input/Audio out	12	Alarm in/Alarm out

2. Connection method

The IP camera can be used with ANNKE NVR, just use a network cable to connect the IP camera to the NVR's PoE network port. And it can also be used alone with an internet connection, connect the camera to the router or switch with a network cable, and power the camera with a DC12V power supply (If the camera is connected to a PoE switch, no separate power supply is required).

1) With ANNKE POE NVR

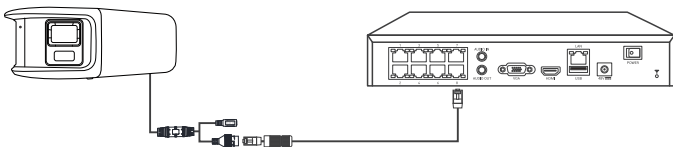

2) Work with Router or Switch;

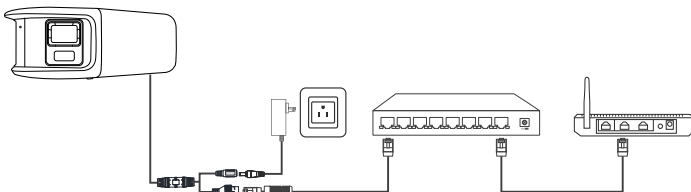

If the device is used with NVR, it can record to the hard disk of NVR; if it is used alone, you need to insert a TF card to record, otherwise it can only be previewed and cannot playback. Open the card slot, insert the TF card, and cover the card slot.

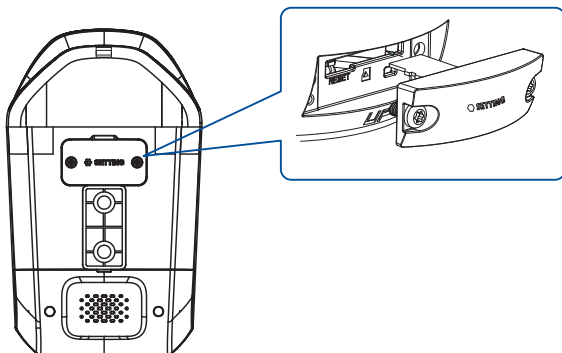

3. Activating your device

When you use your camera with ANNKE NVR, the camera will be automatically activated by the NVR, and the activation password of the camera is the login password of the connected NVR. When you use your camera alone, you can activate your camera through a web browser, PC software SADP or client Guarding vision, or your mobile phone APP ANNKE Vision.



Strong Password recommended– We highly recommend you create a strong password of your own choosing (using a minimum of 8 characters, including upper case letters, lower case letters, numbers, and special characters) in order to increase the security of your product. And we recommend you reset your password regularly, especially in the high security system, resetting the password monthly or weekly can better protect your privacy.

If you want to view remotely when using the camera alone, you need to set a verification code for stream encryption, which consists of 6 to 12 digits or letters(ABCDEF is not allowed). You can find the settings at web setting: configuration>Network>Advanced settings>Platform Access.

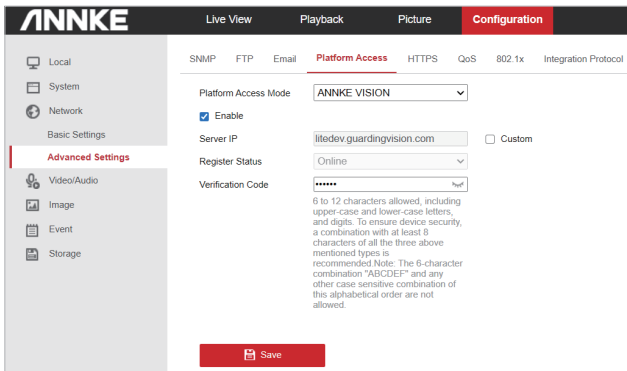

4. Operate IP camera via browser

All camera functions can be set via a browser, such as motion detection, flashing alarm light output, audible alarm output, network settings, TF card formatting, etc. We recommend that you set the required functions on the web page before using the IP Camera.

4.1 Operate IP Cameras via IE Browser

1. Install the SADP software and search the camera. You can download SADP software from our website:

<https://www.annke.com/pages/download-center>.

("Download-center>Software>SADP Tool For Windows/Mac")

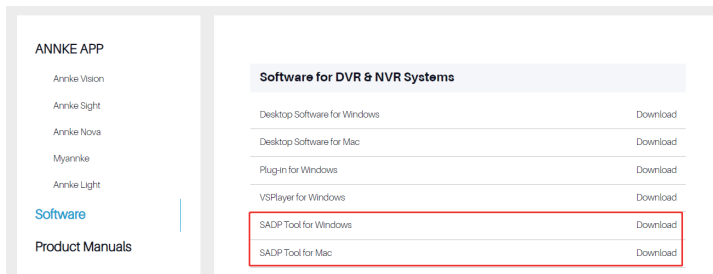

The screenshot shows the Annke website's download center. On the left, there is a navigation menu with 'ANNKE APP' (including Annke Vision, Annke Sight, Annke Nova, Myannke, Annke Light), 'Software', and 'Product Manuals'. The 'Software' section is highlighted. The main content area is titled 'Software for DVR & NVR Systems' and lists several software options with 'Download' links. A red box highlights the 'SADP Tool for Windows' and 'SADP Tool for Mac' entries.

Software for DVR & NVR Systems	
Desktop Software for Windows	Download
Desktop Software for Mac	Download
Plug-in for Windows	Download
VSPlayer for Windows	Download
SADP Tool for Windows	Download
SADP Tool for Mac	Download

2. Check the box of the camera and then activate the camera by creating a login password.

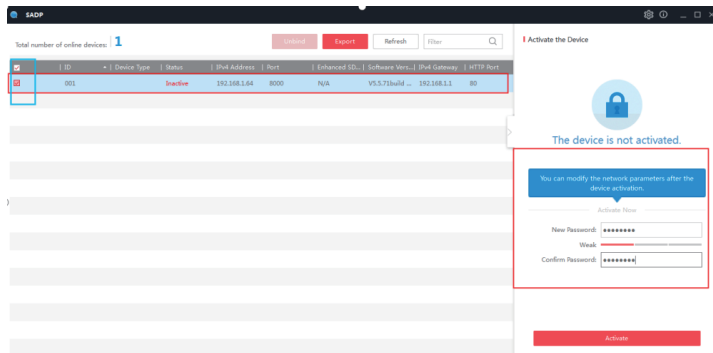

The screenshot shows the SADP software interface. On the left, a table lists online devices. A red box highlights the first device, which is selected. On the right, an 'Activate the Device' screen is displayed. A red box highlights the activation form, which includes a message 'The device is not activated.', a note 'You can modify the network parameters after the device activation.', and fields for 'New Password', 'Weak' (password strength indicator), and 'Confirm Password'. An 'Activate' button is at the bottom.

ID	Device Type	Status	IPv4 Address	Port	Enhanced ID	Software Ver.	IPv4 Gateway	HTTP Port
001		Online	192.168.1.94	8000	N/A	V5.5.71build ...	192.168.1.1	80

3. Double click the camera's address or you can input the IP address on the IE browser to enter the login page. The default account name is admin and the password is the one you just set up.

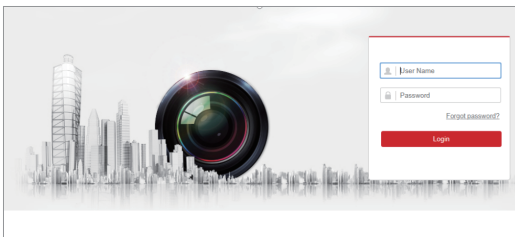

4. Download and install the plug-in to view live video and manage the camera. Close the browser when installing the plug-in.

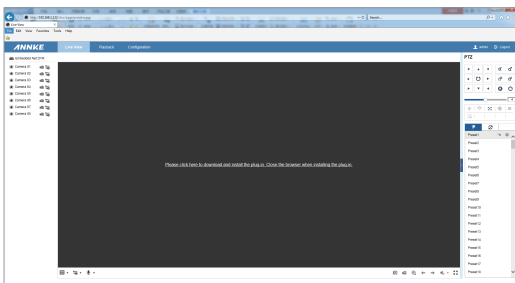

5. Re-open the IE browser and log in the camera. Choose the channel you want to access and set up the camera by clicking Configuration.

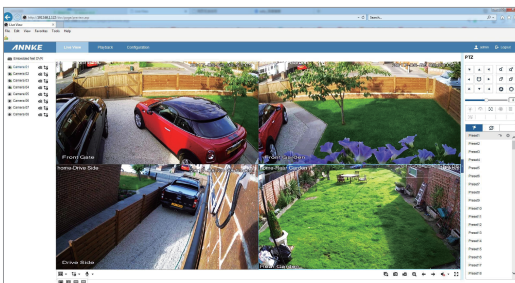

6. Alarm settings.

This series device have **deep-learning** algorithms that distinguishes **people and** vehicles from other targets, which help you take security to the next level with accurate, real-time threat detection. You can set the function in web settings: Configuration>Event>Basic event>Motion detection. Enable motion detection, set the area, arming schedule, and linkage method as you need, and then save the settings.

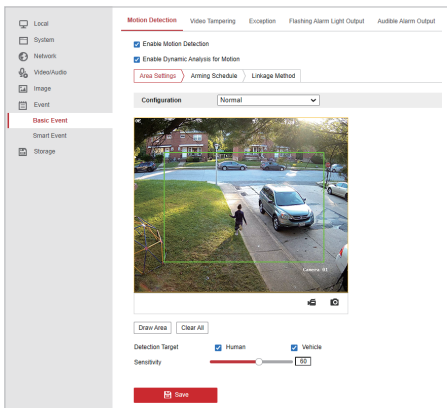

Go to audible alarm, you can set the sound type, alarm times ,sound volume,etc. Custom sounds are also supported. After enabling Audible Warning and setting Audible Alarm Output, the built-in speaker of the device or connected external speaker plays warning sounds when an alarm occurs.

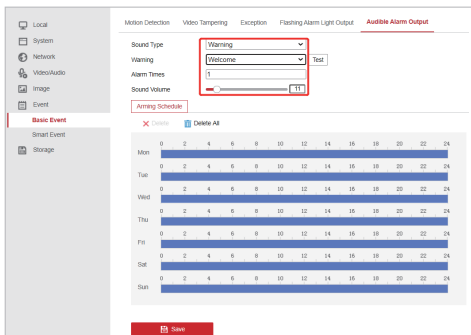

7. Please set the best splicing distance. The farther the distance is, the worse the splicing effect will be. For example, the default splicing distance is 10 meters, and the splicing effect of 10 meters away from the lens is the best. It is recommended to measure the distance between the lower equipment and the optimal splicing surface before setting, and then fill in the actual value.

The screenshot shows the ANNKE Vision web interface. On the left is a navigation menu with options: Local, System, System Settings (highlighted), Maintenance, Security, User Management, Network, Video/Audio, Image, Event, and Storage. The main content area has tabs for Basic Information, Time Settings, DST, RS-232, Image Stitching (selected), and About. Under the 'Image Stitching' tab, there is an 'Advanced Settings' section. The 'Best Stitching Distance' is set to 10 m. Below this is a diagram of a camera lens with a vertical line labeled 'R' extending to a curved line representing the splicing surface. Below the diagram, it says 'R = Best Stitching Distance'. A red 'Save' button is at the bottom.

5. Remote live stream via APP ANNKE Vision

Before you start

1. Make sure your camera and mobile device have been connected to the Internet.
2. Download the app ANNKE VISION from Google Play or App Store.
3. Sign up and Login.
(*Note: Please select the correct country/region when you register an account, it cannot be changed once selected.)
4. Please Make sure that the status of P2P shows "Online", Go to web view of the IPC and enable the P2P (Configuration > Network > Advanced Settings > Platform Access). You also need to set Verification Code (6 to 12 characters allowed, including upper-case and lower-case letters, and digits).

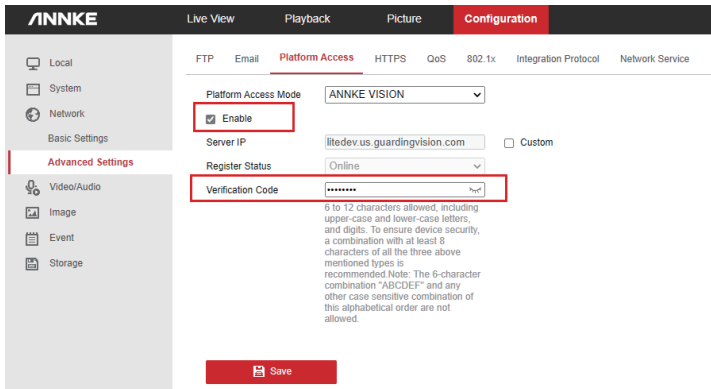

Use IPC Independently

1. Add device to account via "Online Device". (Make sure your phone and device are under the same network)
2. Now you can get the remote live view.
(Please reboot the device if you can't add the device to app, make sure the P2P status is Online)

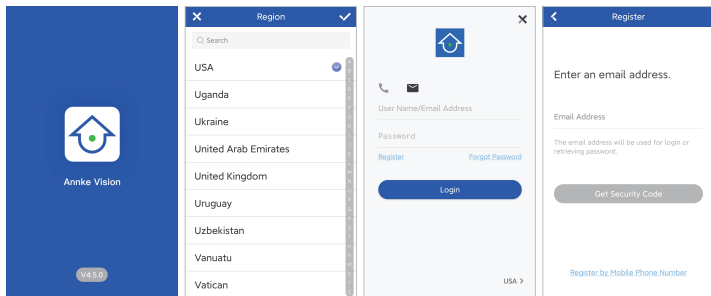

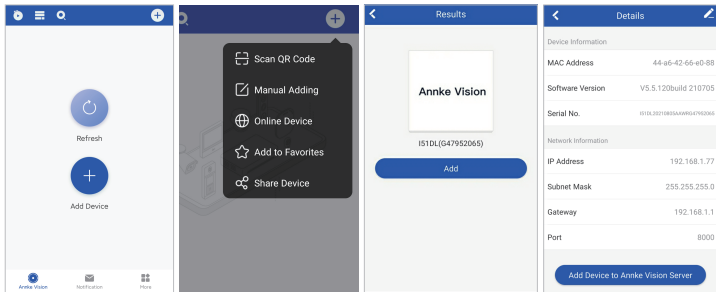

6. Operate IP camera via PC client Guarding Vision

1. Install the desktop software **Guarding Vision** and search the camera. You can download Guarding Vision from our website:
<https://www.annke.com/pages/download-center>



2. Launch Guarding Vision software. The control panel and live view interface of Guarding Vision are shown below.

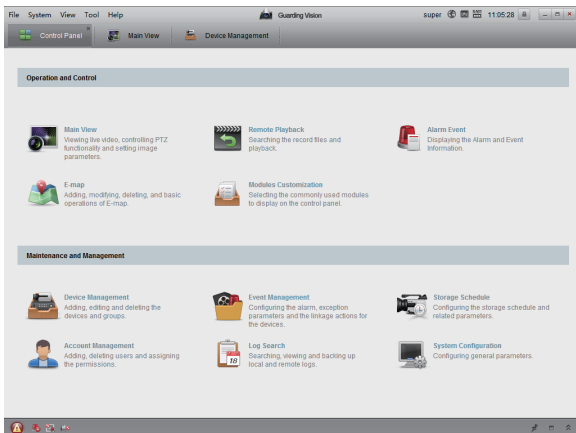

3. Go to Control Panel-Device Management-Device. At the bottom of the screen and in the Online Devices section, the screen will display all devices on the network. Create a password to activate the device if the device's status is inactive.

4. Click Add to Client. Input Nickname, User Name and Password (the password is the same as your activated password instead of the verification code). Click Add to add the device to the client software (as shown in the picture below).

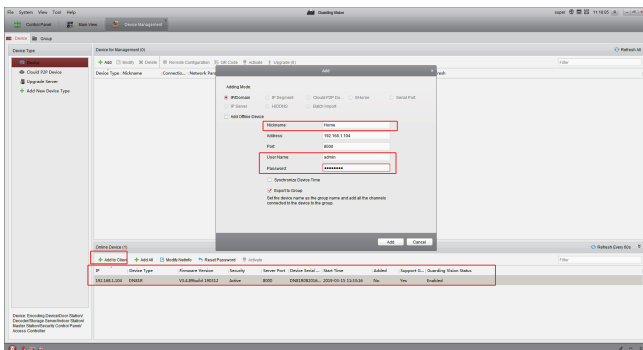

Note: If you want to access the camera remotely via the desktop software Guarding Vision, please choose **Guarding Vision Device** and log in your cloud account to view remote live stream.

5. Go to Control Panel—Main View. If you have added the IP camera, you can get a live view in the screen (as shown in the picture below).

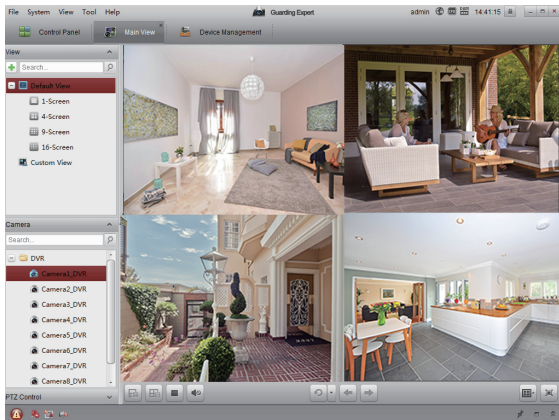

For more information, please press F1 to get user manual.

7. View live stream via RTSP protocol

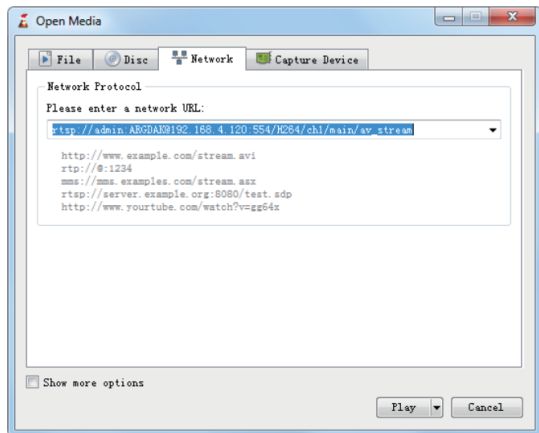

The IP camera supports RTSP protocol. The camera can be accessed via the VLC player, Blue Iris, tinyCam and other software that supports RTSP.

The correct description of RSTP is as below:

rtsp://[username]: [password]@[ip]: [port]/[codec]/[channel]/[subtype]/av_stream

User name: admin (default)

Password: The password is the login password used to active your device.

IP: You can get the camera's IP address on the SADP software.

Port: 554

Codec: H264 (H.265)

Channel: ch1 (or the channel which you want to add, for example ch2)

Subtype: main (sub)

Fox example:

rtsp://admin:qwer1234@192.168.1.64:554/H264/ch1/main/av_stream

Common rtsp/onvif address:

rtsp://[your device ip address]:554/Streaming/Channels/101? transportmode=unicast&profile=Profile_1

http://[your device ip address]:80/onvif/device_service

8. Work with ANNKE NVR

This IP camera can be connected to ANNKE NVR. NVR needs to support 6MP IP Camera access, otherwise it may not be able to display the picture normally.

Operation Step:

1. Use a network cable to connect the IPC to the NVR's POE network port.

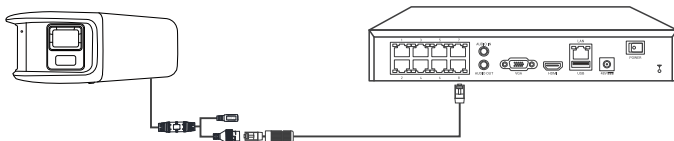

2. Wait for a while, the live view of the camera will be displayed on the monitor.

9. Install the Camera

1. Paste the drill template (supplied) to the desired mounting position.
2. Drill the screw holes in the ceiling according to the supplied drill template.
3. Install and fix the bracket with screws.
4. Fix the IP camera to the bracket with screws.
5. Connect the cables and power on the camera to view live view image.
6. Adjust the surveillance angle.

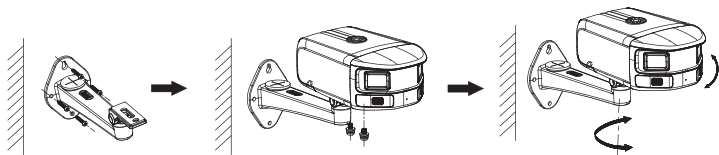

10. Waterproof the camera.

If the camera is installed outdoor, you should use the waterproof accessory or tapes to waterproof the cables. Otherwise the cables might get wet or a short circuit occurs.

10.1 Install Network Cable Waterproof Jacket

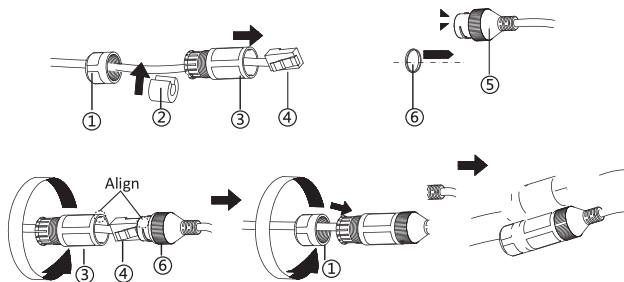

1. Feed the network cable through ① and ③ in order.
2. Fix ② on the network cable between ① and ③.
3. Place Rubber O-Ring ⑤ onto the end of camera RJ45 interface ⑥, and plug the RJ45 male connector into RJ45 female connector.
4. Screw ③ to ⑥ clockwise
5. Push ② into ③.
6. Secure ① with the ③ in clockwise direction.

Note: Don't put Rubber O-ring ⑤ in a wrong position, otherwise there will be a gap, which may lead to water ingress.

10.2 Waterproof Other Cables

After routing and connecting the cables, use the waterproof tapes to wrap up the cables. Connected cables and spare cables both should be wrapped up as the figures below.

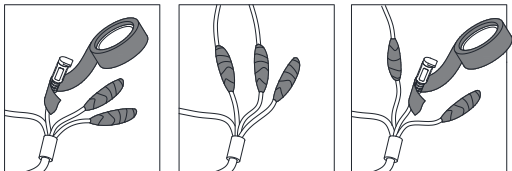

1. Schnittstelleneinführung

Die Abbildungen und Beschreibungen in diesem Handbuch dienen nur als Referenz, beziehen Sie sich bitte auf das tatsächliche Produkt.

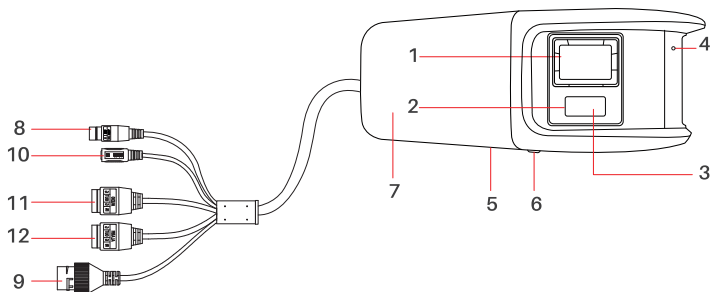

Nr.	Beschreibung	Nr.	Beschreibung
1	Mikrofon	2	Objektiv
3	Weißes Licht	4	Zusatzlicht
5	Reset-Taste	6	Speicherkartensteckplatz
7	Lautsprecher	8	DC 12V Ausgang
9	PoE- und Netzwerkschnittstelle	10	12-V-Gleichstromschnittstelle
11	Audio input/Audio out	12	Alarめingang/Alarmausgang

2. Verbindungsmethode

Die IP-Kamera kann mit ANNKE NVR verwendet werden, einfach ein Netzwerkkabel verwenden, um die IP-Kamera an den PoE-Netzwerkport des NVR anzuschließen. Und es kann auch alleine mit einer Internetverbindung verwendet werden, die Kamera an den Router oder Switch mit einem Netzwerkkabel anschließen und die Kamera mit einer DC12V-Stromversorgung versorgen (Wenn die Kamera an einen PoE-Switch angeschlossen ist, ist keine separate Stromversorgung erforderlich).

1) Mit ANNKE PoE NVR

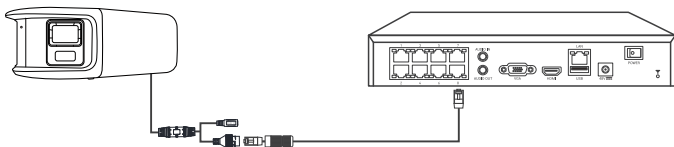

2) Arbeiten Sie mit Router oder Switch

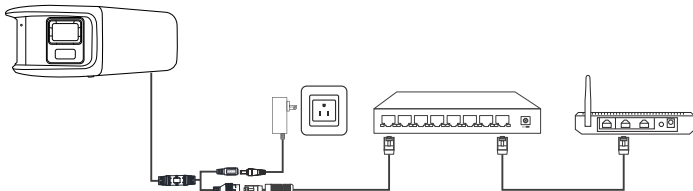



Shenzhen Kean Digital co.,Ltd.

Address: Room 1001, Rujun Building, No.105 Center Road,
Bantian Street, Longgang District, Shenzhen, China.518000

Tech Support Email Address: support@annke.com



THEMIS AR Unterstützung UG

Beedstrasse 54, In Dusseldorf, (40468), Deutschland



Made in China

www.annke.com